



نصب و اجرای بیس پلیت و ستون فلزی

استاد: مهندس ابراهیم اصغری

گردآورنده: طیب زارعی مقدم، مرتضی مقبلی



فصل اول :

بوت



بالت

(1) كار بالت ها

(2) قطر و اندازه بالت ها

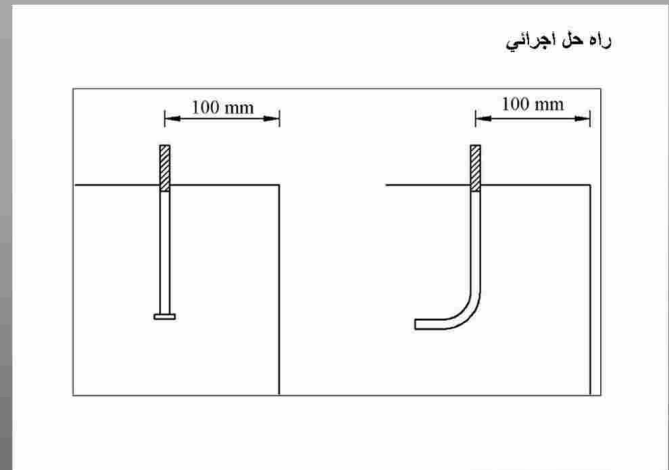













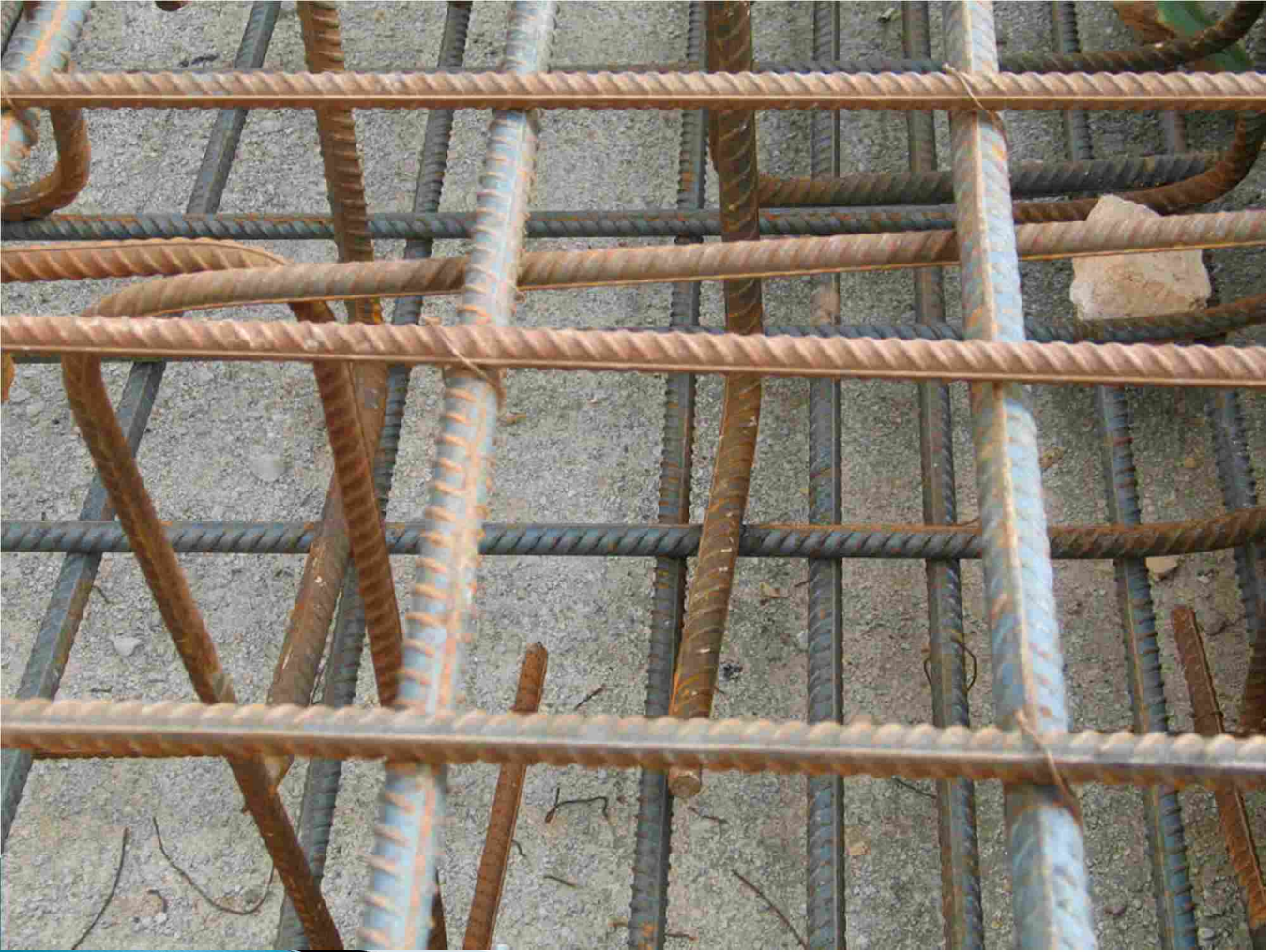



فصل دوم :

بیس پلٹ

بيس پليت

- (1) كار بيس پليت
- (2) برش پليت
- (3) نصب بيس پليت



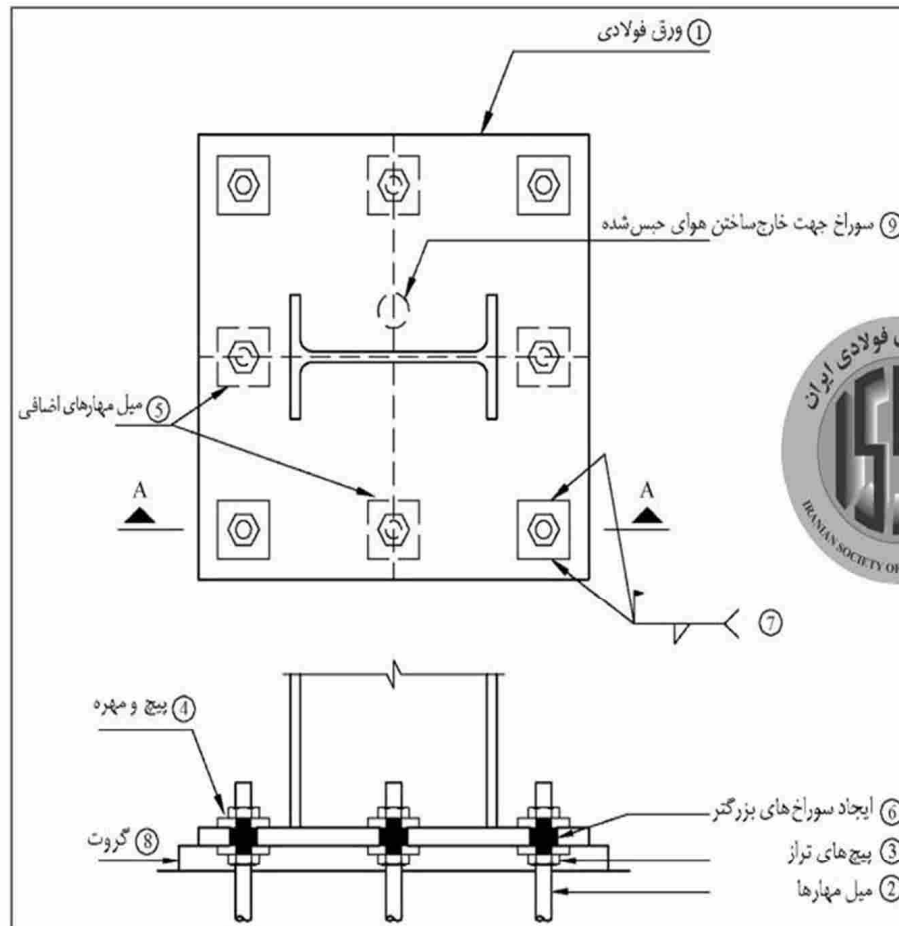































فصل سوم:

ستون

ستون

- 1) قسمتهای اصلی ستون
- 2) تسمه های اتصال دهنده
- 3) صفحه های تقویتی
- 4) جوش
- 5) اتصال ستون به صفحه زیرستون



قسمتهای اصلی ستون



















تسمه های اتصال دهنده













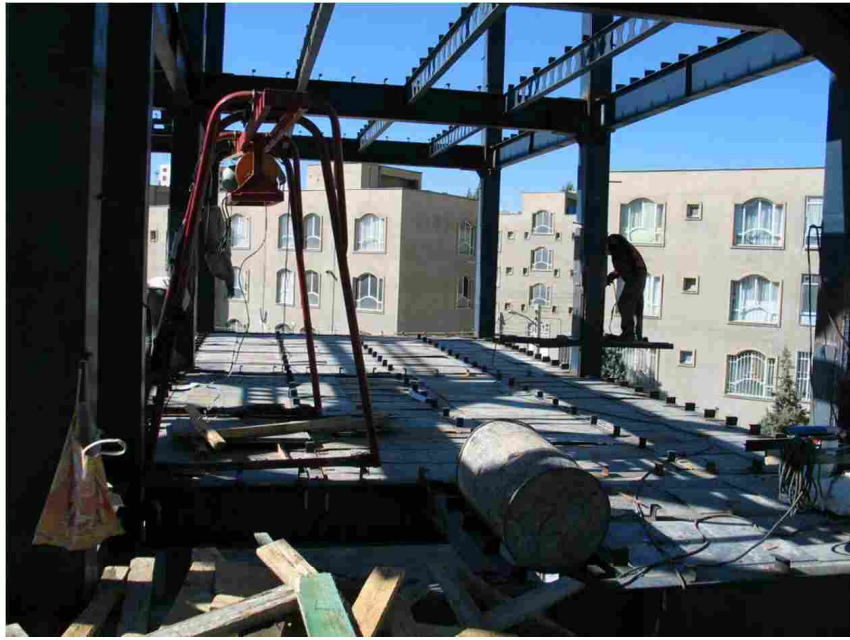



صفحه های تقویتی



سخت کننده ها

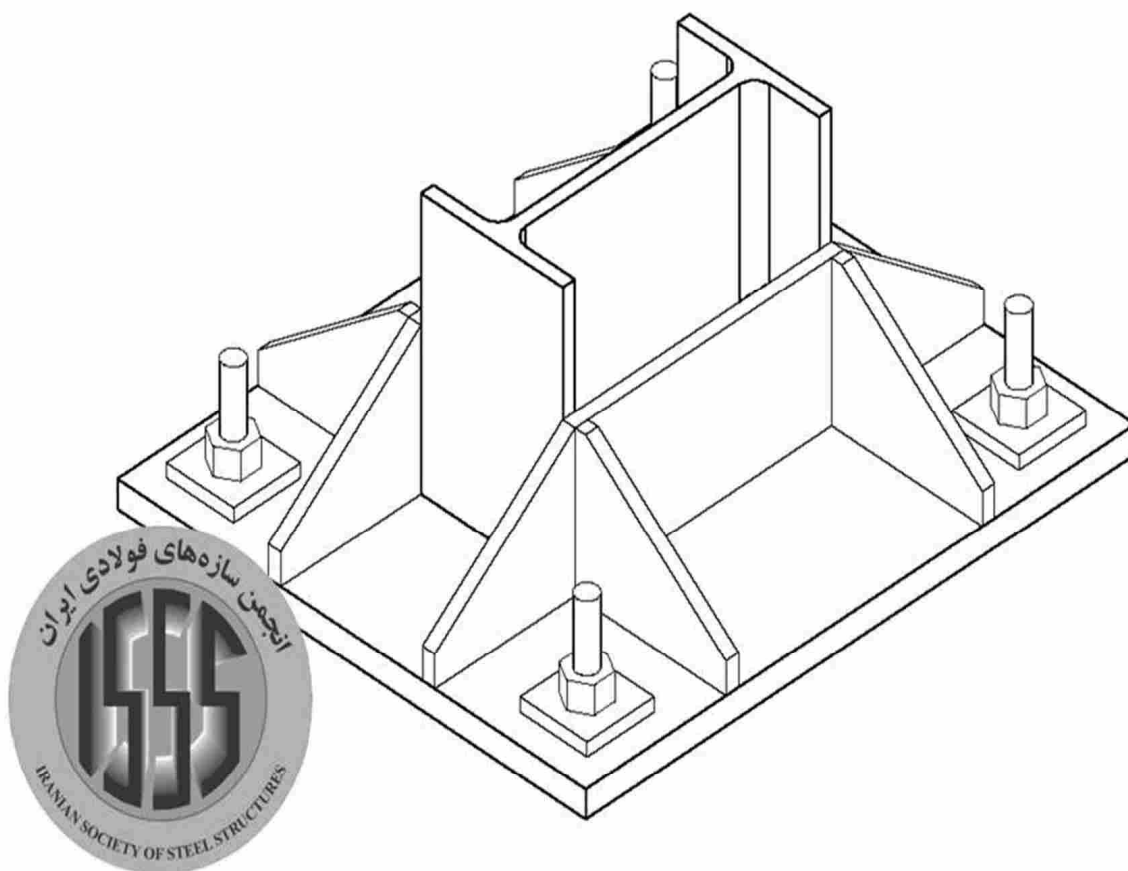







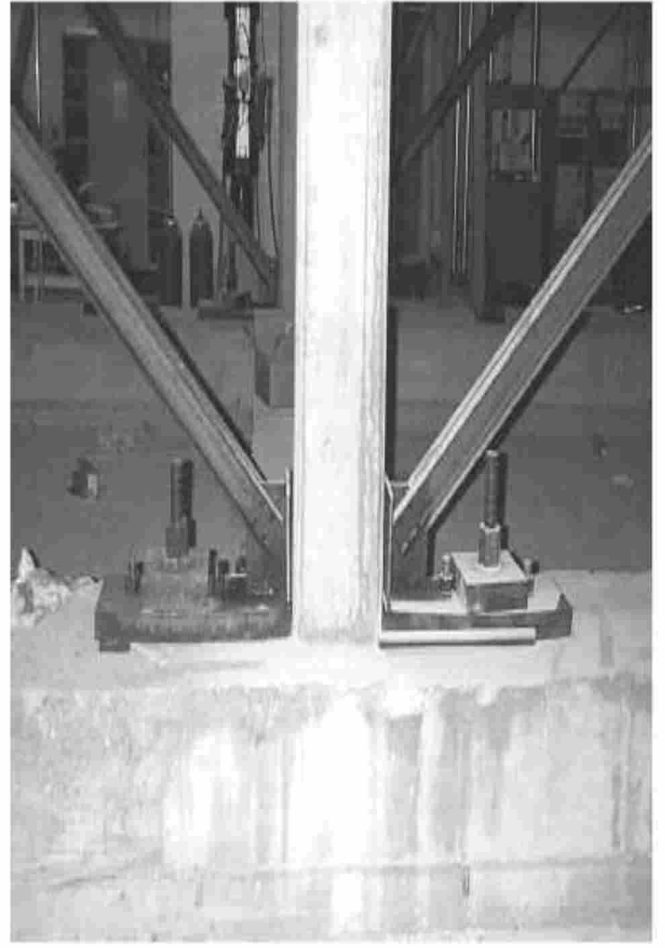
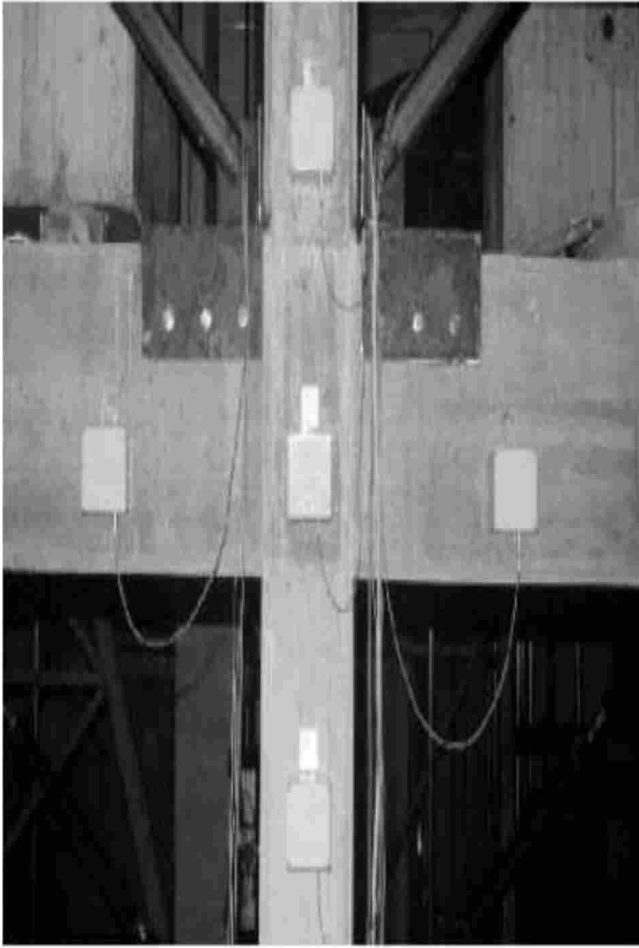

جوئش



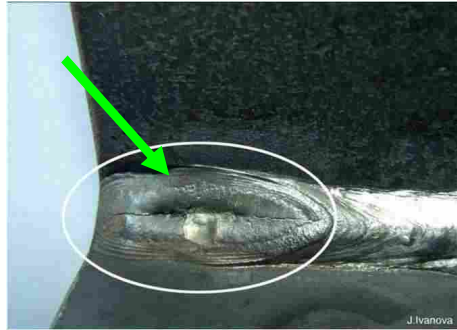
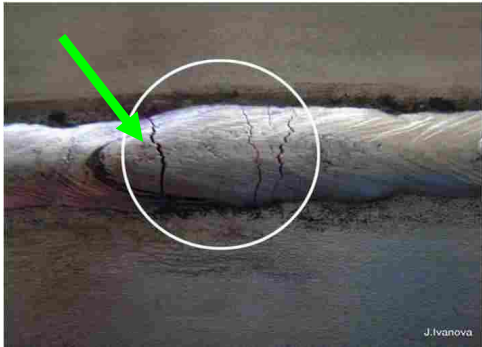



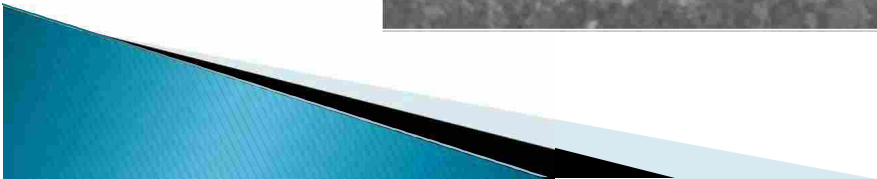
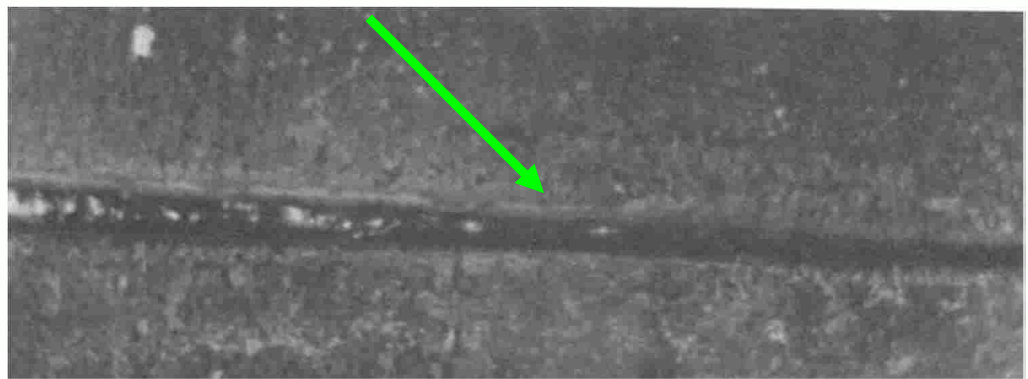
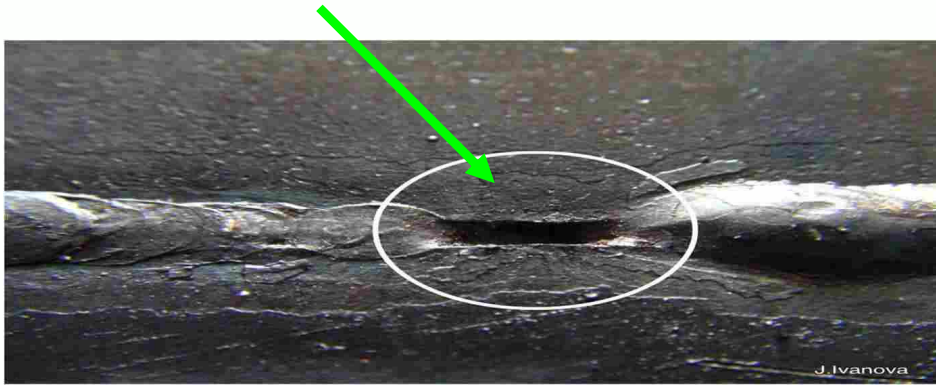

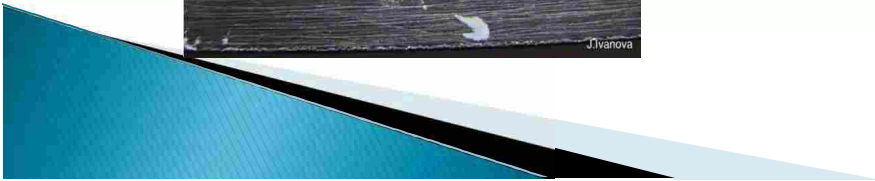
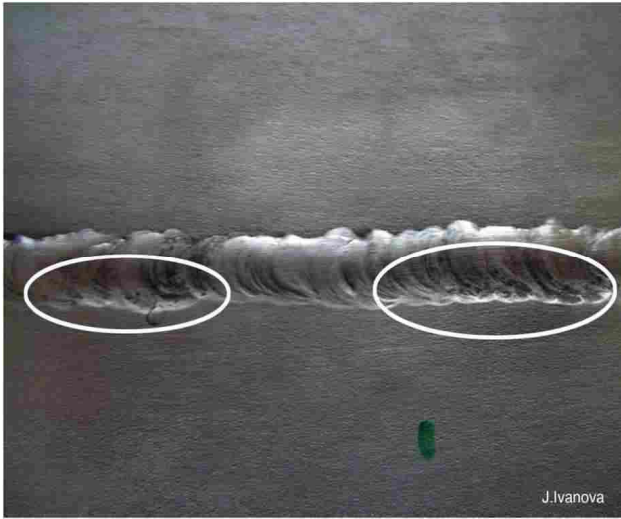

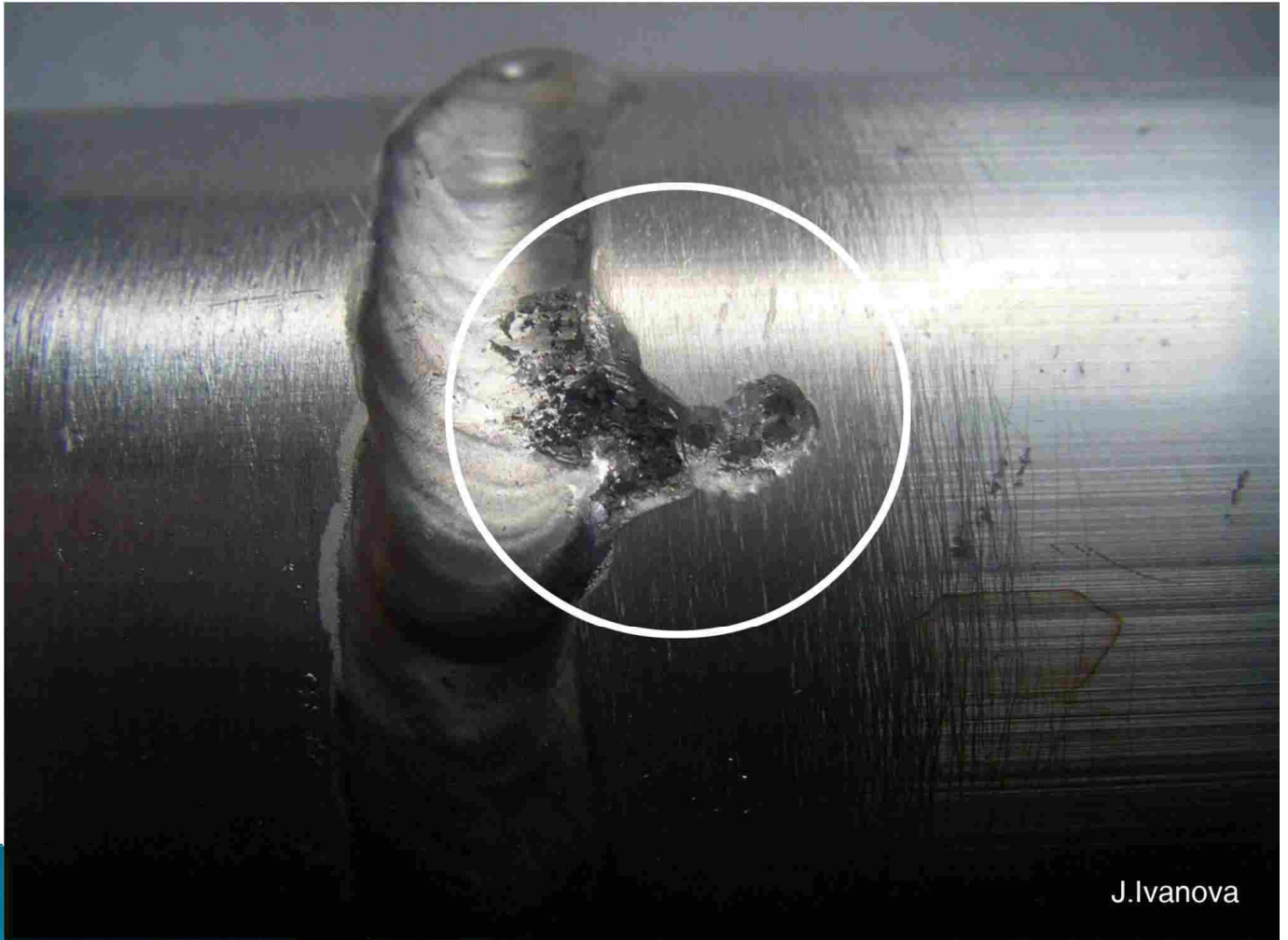

J.Ivanova

اتصال ستون به صفحه زیر ستون



















پایان

با تشکر...

